

Powered by



HR 1234W ▶ 12V 34W

HR 1234W is specially designed for high efficient discharge application. Its characteristics are high energy density, small footprint and high discharge efficiency. It can be used for more than 260 cycles at 100% discharge in cycle service, up to 5 years in standby service.



► Specification

Cells Per Unit	6
Voltage Per Unit	12
Capacity	34W @ 15min-rate to 1.67V per cell @25 °C (77°F)
Weight	Approx. 2.5 kg(5.51 lbs)
Maximum Discharge Current	100/130A(5sec)
Internal Resistance	Approx. 19 mΩ
Operating Temperature Range	Discharge: -15°C~50°C (5°F~122°F) Charge: -15 °C~40°C (5°F~104°F) Storage: -15°C~40°C (5°F~104°F)
Nominal Operating Temperature Range	25°C±3°C(77°F±5°F)
Float Charging Voltage	13.5 to 13.8 VDC/unit Average at 25°C(77°F)
Recommended Maximum Charging Current Limit	3.4A
Equalization and Cycle Service	14.4 to 15.0 VDC/unit Average at 25°C(77°F)
Self Discharge	CSB Batteries can be stored for more than 6 months at 25°C(77°F). Please charge batteries before using. For higher temperatures the time interval will be shorter.
Terminal	F1/F2-Faston Tab187/250
Container Material	ABS(UL 94-HB) & Flammability resistance of (UL 94-V0) can be available upon request.



CSB-manufactured VRLA batteries are UL-recognized components under UL1989.

CSB is also certified by ISO 9001 and ISO 14001.

Dimensions :	Overall Height (H)	Container height (h)	Length (L)	Width (W)
Unit: mm (inch)	100.5±1.5 (3.96±0.06)	94.3±1.0 (3.71±0.04)	151.0±2.0 (5.94±0.08)	65.0±1.0 (2.56±0.04)

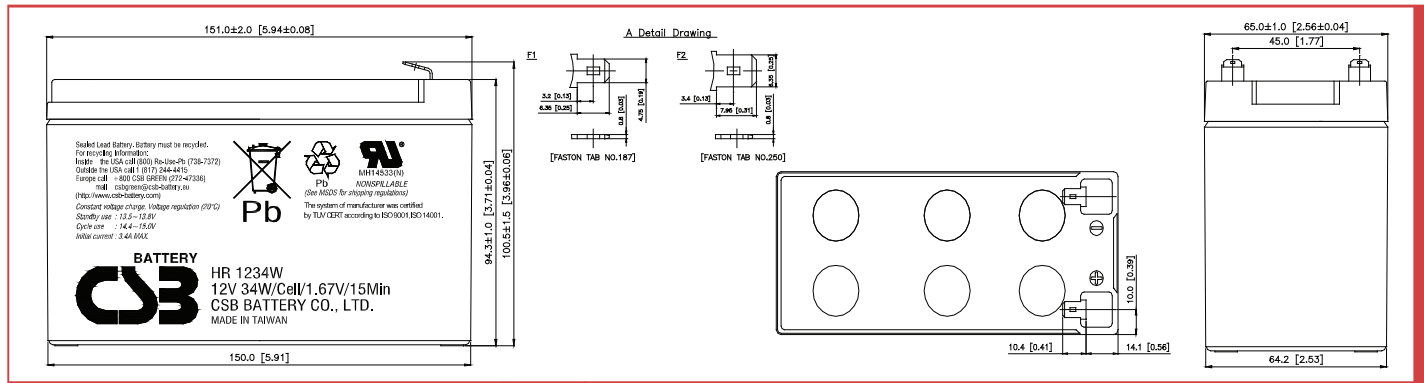

Constant Current Discharge Characteristics Unit:A (25°C ,77°F)

F.V/Time	2MIN	4MIN	6MIN	8MIN	10MIN	15MIN	20MIN	30MIN	60MIN	90MIN
1.60V	73.8	49.2	36.8	29.7	25.4	18.5	14.6	10.5	5.99	4.25
1.67V	65.8	44.8	34.4	28.2	24.2	17.8	14.1	10.3	5.86	4.15
1.70V	62.2	42.9	33.3	27.5	23.6	17.4	13.8	10.1	5.80	4.11
1.75V	56.3	39.8	31.6	26.2	22.7	16.8	13.5	9.90	5.69	4.05
1.80V	50.3	36.4	29.7	24.9	21.7	16.2	13.1	9.66	5.60	3.99
1.85V	43.3	32.9	27.6	23.5	20.7	15.6	12.7	9.39	5.50	3.92

Constant Power Discharge Characteristics Unit:W (25°C ,77°F)

F.V/Time	2MIN	4MIN	6MIN	8MIN	10MIN	15MIN	20MIN	30MIN	60MIN	90MIN
1.60V	706	506	395	328	286	211	169	124	71.7	50.8
1.67V	645	470	376	315	276	205	165	121	70.5	50.1
1.70V	618	454	366	308	270	202	163	120	70.0	49.6
1.75V	571	426	350	296	260	196	160	118	69.0	49.0
1.80V	524	400	333	285	250	191	156	116	68.1	48.3
1.85V	478	376	316	273	241	186	152	114	67.0	47.7

Ratings presented herein are subject to revision without notice. Please refer to www.csb-battery.com to confirm the latest version.

Trickle (or Float) Service Life

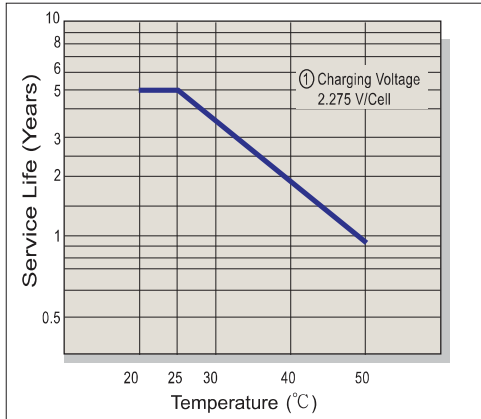

Capacity Retention Characteristic

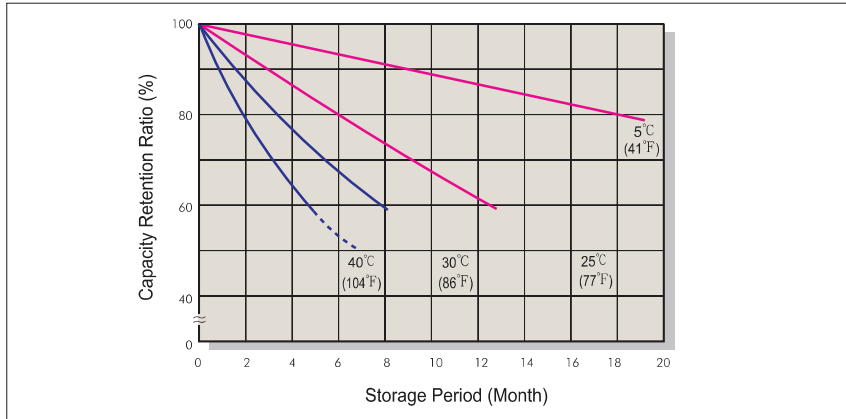

Battery Voltage and Charge Time for Standby Use

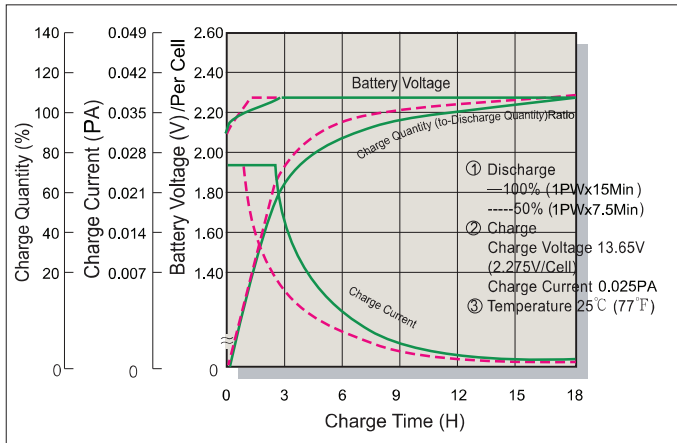

Cycle Service Life

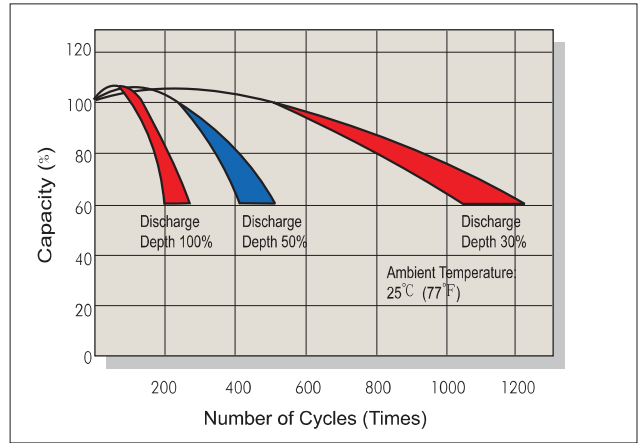

Battery Voltage and Charge Time for Cycle Use

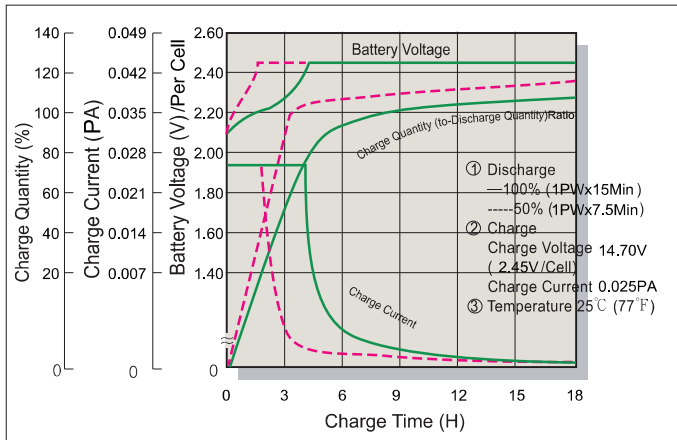

Terminal Voltage (V) and Discharge Time

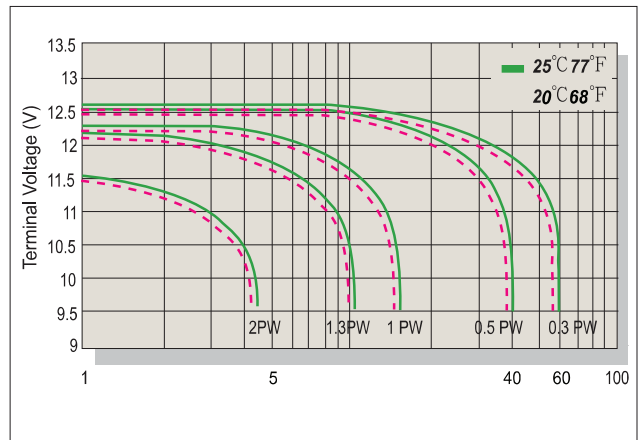

Charging Procedures

Application	Charge Voltage(V/Cell)			Max.Charge Current
	Temperature	Set Point	Allowable Range	
Cycle Use	25°C(77°F)	2.45	2.40-2.50	0.1PA
Standby	25°C(77°F)	2.275	2.25-2.30	

Discharge Current VS. Discharge Voltage

Final Discharge Voltage V/Cell	1.75	1.70	1.60	1.30
Discharge Power(W)	0.1P>(W)	0.1P≤(W)<0.25P	0.25P≤(W)<1.0P	(W)≥1.0P

Sales Office URL: WWW.CSB-BATTERY.COM

GLOBAL HQ
CSB BATTERY CO., LTD. (TAIWAN)
 Tel : +886-2-2880-5600
 Fax : +886-2-2888-3300
 mail : service@csb-battery.com.tw

BEIJING OFFICE. (CHINA)
CSB BATTERY TECHNOLOGIES (BEIJING) CO., LTD.
 Tel : +86-10-5820-5336/5338
 Fax : +86-10-58203053
 mail : chinasls@csb-battery.com

AMERICA HQ
CSB BATTERY TECHNOLOGIES INC. (U.S.A)
 Tel : +1-817-244-7777/1-(800)3-CSB-USA(272872)
 Fax : +1-817-244-4445
 mail : csb@csb-battery.com

SHANGHAI OFFICE. (CHINA)
CSB BATTERY LOGISTIC (SHANGHAI) CO., LTD.
 Tel : +86-21-5046-1622/5046-0833
 Fax : +86-21-5064-1046
 mail : chinasls@csb-battery.com

EUROPE HQ
CSB Battery Europe BV.
 Tel : +31(0)-180-418-140
 Fax : +31(0)-180-418-327
 mail : eurosales@csb-battery.eu

SHENZHEN OFFICE. (CHINA)
CSB BATTERY LOGISTIC (SHANGHAI) CO., LTD.
 Tel : +86-755-8831-6488/6396/6356
 Fax : +86-755-8831-6548
 mail : she@csb-battery.com.cn