

CODE: **ARAS800** v.1.2/V  
 NAME: **ARAD rails dedicated for RACK19" cabinets - 800mm depth**

EN

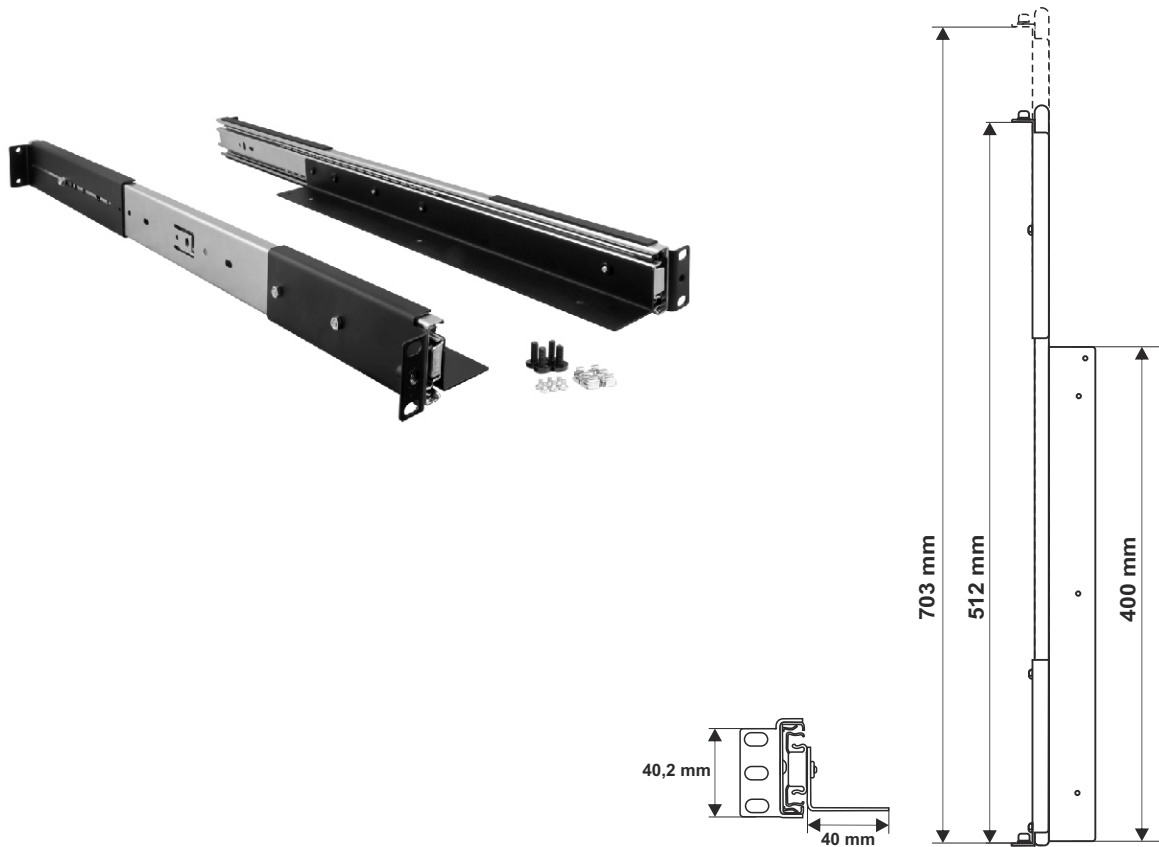

## DESTINATION

**ARAS800** rail is intended for mounting RACK enclosures, type: ARAD2 / ARAD3 / ARAD4 in a 800mm deep RACK 19" cabinet.

## TECHNICAL DATA

<b>Mounting dimensions:</b>	H=1U, D=512+703 [mm, +/-2]
<b>Net/gross weight:</b>	2,84 / 2,97 [kg]
<b>Material:</b>	- sheet metal DC01, 1mm thick, color: RAL9005 - sliding rails – fully extendable
<b>Static load:</b>	30kg
<b>Notes:</b>	- four-point butt mounting to RACK profiles + supported on front and rear RACK profiles - 4 M6 screws + cage nuts included - 6 M4 screws included – to bolt the RACK enclosure
<b>Destination:</b>	inside
<b>Warranty:</b>	2 years from production date