



60W Multiple-Stage Constant Current Mode LED Driver

LCM-60DA series



Features

- Constant Current mode output with multiple levels selectable by dip switch
- Emergency lighting application is available according to IEC61347-2-13
- Built-in active PFC function and class II design
- Standby power consumption <0.5W
- Functions: DALI interface(logarithm or linear dimming curve selectable), push dimming synchronization up to 10units
- 3 years warranty

Applications

- LED indoor lighting
- LED office lighting
- LED commercial lighting
- LED panel lighting
- Industrial lighting

Description

LCM-60DA series is a 60W AC/DC constant current mode output LED driver featuring the multiple levels selectable by dip switch and the DALI interface with the compliance to IEC62386. LCM-60DA operates from 180~295VAC and offers different current levels ranging between 500mA and 1400mA. Thanks to the high efficiency up to 92%, with the fanless design, the entire series is able to operate for -30°C~+90°C case temperature under free air convection. In addition, LCM-60DA is equipped with push dimming and synchronization functions, so as to provide the optimal design flexibility for LED lighting system.

Model Encoding

LCM - 60DA - AUX

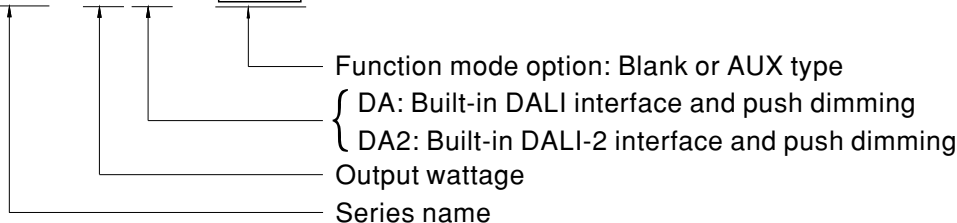

Type	Function	Note
Blank	standby power consumption <0.5W	In Stock
AUX	standby power consumption <1.2W and Auxiliary DC output(12V/50mA)	By request

SPECIFICATION

MODEL		LCM-60□-□					
OUTPUT	CURRENT LEVEL	Current level selectable via DIP switch, please refer to "DIP SWITCH TABLE" section					
		500mA	600mA	700mA(default)	900mA	1050mA	1400mA
	RATED POWER	60.3W					
	DC VOLTAGE RANGE	2 ~ 90V	2 ~ 90V	2 ~ 86V	2 ~ 67V	2 ~ 57V	2 ~ 42V
	OPEN CIRCUIT VOLTAGE (max.)	95V			73V		
	CURRENT RIPPLE Note.5	5.0% max. @rated current					
	CURRENT TOLERANCE	±5%					
	AUXILIARY DC OUTPUT	Nominal 12V(deviation 11.4~12.6V)@50mA for AUX-Type only					
SETUP TIME Note.3 Note.9	500ms / 230VAC						
INPUT	VOLTAGE RANGE Note.2	180 ~ 295VAC 254 ~ 392VDC (Please refer to "STATIC CHARACTERISTIC" section)					
	FREQUENCY RANGE	47 ~ 63Hz					
	POWER FACTOR (Typ.)	PF ≥ 0.975/230VAC, PF ≥ 0.95/277VAC@full load (Please refer to "POWER FACTOR (PF) CHARACTERISTIC" section)					
	TOTAL HARMONIC DISTORTION	THD < 20% (@load ≥ 75%) (Please refer to "TOTAL HARMONIC DISTORTION(THD)" section)					
	EFFICIENCY (Typ.) Note.4	92%					
	AC CURRENT (Typ.)	0.32A/230VAC 0.27A/277VAC					
	INRUSH CURRENT (Typ.)	COLD START 20A(t _{width} =270μs measured at 50% I _{peak}) at 230VAC; Per NEMA 410					
	MAX. No. of PSUs on 16A CIRCUIT BREAKER	25 units (circuit breaker of type B) / 32 units (circuit breaker of type C) at 230VAC					
	LEAKAGE CURRENT	<0.5mA / 240VAC					
STANDBY POWER CONSUMPTION Note.6	<0.5W for Blank-Type, <1.2W for AUX-Type						
PROTECTION	SHORT CIRCUIT	Constant current limiting, recovers automatically after fault condition is removed					
	OVER VOLTAGE	105 ~ 125V					
		Shutdown o/p voltage, re-power on to recover					
OVER TEMPERATURE	Shutdown o/p voltage, re-power on to recover						
FUNCTION	DIMMING	Please refer to "DIMMING OPERATION" section					
	SYNCHRONIZATION	Please refer to "SYNCHRONIZATION OPERATION" section					
	TEMP. COMPENSATION	By external NTC, please refer to "TEMPERATURE COMPENSATION OPERATION" section					
ENVIRONMENT	WORKING TEMP.	T _{case} = -30 ~ +90°C (Please refer to "OUTPUT LOAD vs TEMPERATURE" section)					
	MAX. CASE TEMP.	T _{case} = +90°C					
	WORKING HUMIDITY	20 ~ 90% RH non-condensing					
	STORAGE TEMP., HUMIDITY	-40 ~ +80°C, 10 ~ 95% RH					
	TEMP. COEFFICIENT	±0.03%/°C (0 ~ 50°C)					
	VIBRATION	10 ~ 500Hz, 2G 10min./1cycle, period for 60min. each along X, Y, Z axes					
SAFETY & EMC	SAFETY STANDARDS	UL8750(except for DA2-Type), CSA C22.2 No.250.13-12, ENEC BS EN/EN61347-1, BS EN/EN61347-2-13, BS EN/EN62384 independent, GB19510.14, GB19510.1, BIS IS15885(except for DA2-Type), EAC TP TC 004 approved; According to BS EN/EN61347-2-13 appendix J suitable for emergency installations					
	DALI STANDARDS	IEC62386-101, 102, 207,251					
	WITHSTAND VOLTAGE	I/P-O/P:3.75KVAC; I/P-DA:1.5KVAC; O/P-DA:1.5KVAC					
	ISOLATION RESISTANCE	I/P-O/P:>100M Ohms / 500VDC / 25°C / 70% RH					
	EMC EMISSION Note.7	Compliance to BS EN/EN55015, BS EN/EN61000-3-2 Class C(@load ≥ 40%); BS EN/EN61000-3-3; GB17625.1,GB17743, EAC TP TC 020					
	EMC IMMUNITY	Compliance to BS EN/EN61000-4-2,3,4,5,6,8,11, BS EN/EN61547, light industry level(surge immunity Line-Line 2KV), EAC TP TC 020					
OTHERS	MTBF	193.6K hrs min. MIL-HDBK-217F (25°C)					
	DIMENSION	123.5*81.5*23mm (L*W*H)					
	PACKING	0.24Kg; 54pcs/15Kg/1.12CUFT					
NOTE	<ol style="list-style-type: none"> All parameters NOT specially mentioned are measured at 230VAC input, rated current and 25°C of ambient temperature. De-rating may be needed under low input voltages. Please refer to "STATIC CHARACTERISTIC" sections for details. Length of set up time is measured at first cold start. Turning ON/OFF the driver may lead to increase of the set up time. Efficiency is measured at 900mA/67V output set by DIP switch. Current ripple is measured 60%~100% of maximum voltage under rated power delivery. Standby power consumption is measured at 180~230VAC. The driver is considered as a component that will be operated in combination with final equipment. Since EMC performance will be affected by the complete installation, the final equipment manufacturers must re-qualify EMC Directive on the complete installation again. The ambient temperature derating of 3.5°C/1000m with fanless models and of 5°C/1000m with fan models for operating altitude higher than 2000m(6500ft). Based on IEC 62386-101/102 DALI power on timing and interruption regulations, the set up time needs to test with a DALI controller which can support for DALI power on function, otherwise the set up time will be higher than 0.5 second for DA2-type. To fulfill requirements of the latest ErP regulation for lighting fixtures, this LED power supply can only be used behind a switch without permanently connected to the mains. <p>※ Product Liability Disclaimer : For detailed information, please refer to https://www.meanwell.com/serviceDisclaimer.aspx</p>						

■ BLOCK DIAGRAM

PFC fosc : 60KHz
PWM fosc : 80KHz

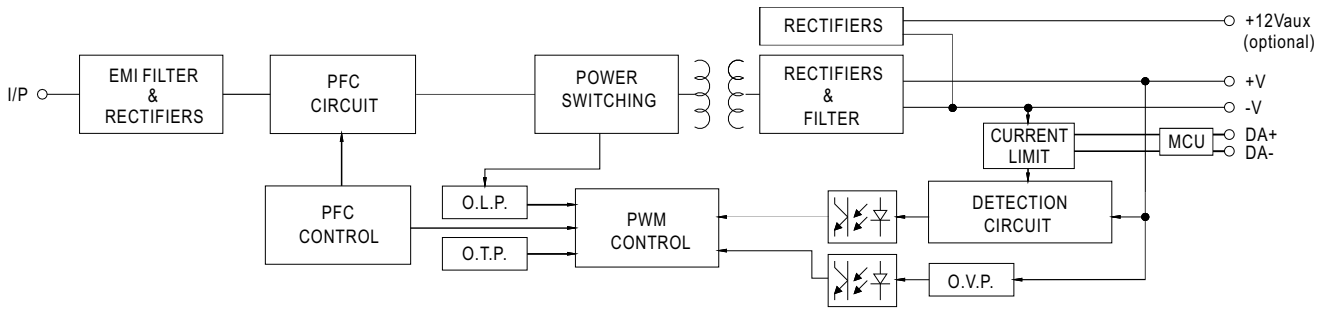

■ DIP SWITCH TABLE

LCM-60DA/DA2 is a multiple-stage constant current driver, selection of output current through DIP switch is exhibited below.

Io \ DIP S.W.	1	2	3	4	5	6
500mA	----	----	----	----	----	----
600mA	ON	----	----	----	----	----
700mA(factory default)	ON	ON	----	----	----	----
900mA	ON	ON	ON	----	----	ON
1050mA	ON	ON	ON	ON	----	ON
1400mA	ON	ON	ON	ON	ON	ON

Note: For more current setting, please contact MW's sales.

■ DIMMING OPERATION

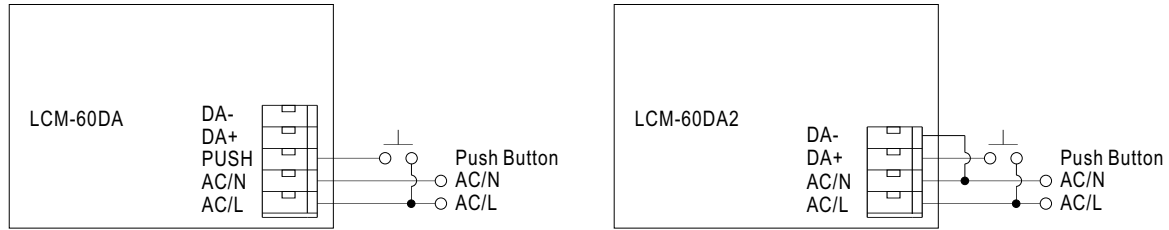

※**PUSH dimming(primary side)**

Action	Action duration	Function
Short push	0.1~1 sec.	Turn ON-OFF the driver
Long push	1.5~10 sec.	Every Long Push changes the dimming direction, dimming up or down
Reset	>11 sec.	Set up the dimming level to 100%

- The factory default dimming level is at 100%.
- If the push action lasts less than 0.05 sec., it will not lead to a change for the status of the driver.
- Up to 10 drivers can perform the PUSH dimming at the same time when utilizing one common push button.
- The maximum length of the cable from the push button to the last driver is 20 meters.
- The additive push button can be connected only between the PUSH terminal, as displayed in the diagram, and AC/L (in brown or black); it will lead to short circuit if it is connected to AC/N.

※**DALI interface(primary side; for DA/DA2-Type)**

- Apply DALI signal between DA+ and DA-
- DALI protocol comprises 16 groups and 64 addresses.
- First step is fixed at 6% of output.

■ SYNCHRONIZATION OPERATION

- Synchronization up to 10 drivers (1 master + 9 slaves)
- Dimming operating range : 10%~100%
- Sync cable length : < 5m
- Sync cable type : Flat cable
- Sync cable cross section area : 22 – 24 AWG (0.2~0.3mm²)

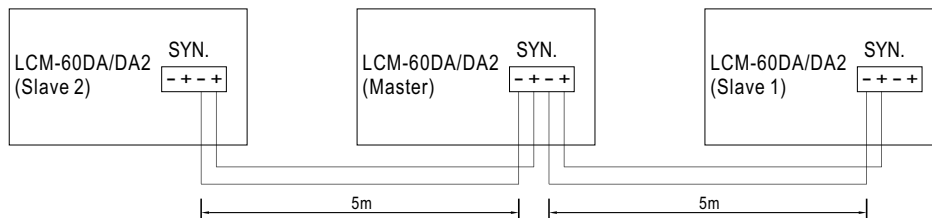

NOTE: 1. Please make sure all units are set to 100% dimming setting (factory default) before synchronizing.
 2. Min. Dimming operating range depends on dimmer setting.

■ TEMPERATURE COMPENSATION OPERATION

LCM-60DA/DA2 have the built-in temperature compensation function ; by connecting a temperature sensor (NTC resistor) between the +NTC / -NTC terminal of LCM-60DA/DA2 and the detecting point on the lighting system or the surrounding environment, output current of LCM-60DA/DA2 could be correspondingly changed, based on the sensed temperature, to ensure the long life of LED.

NTC derating curve

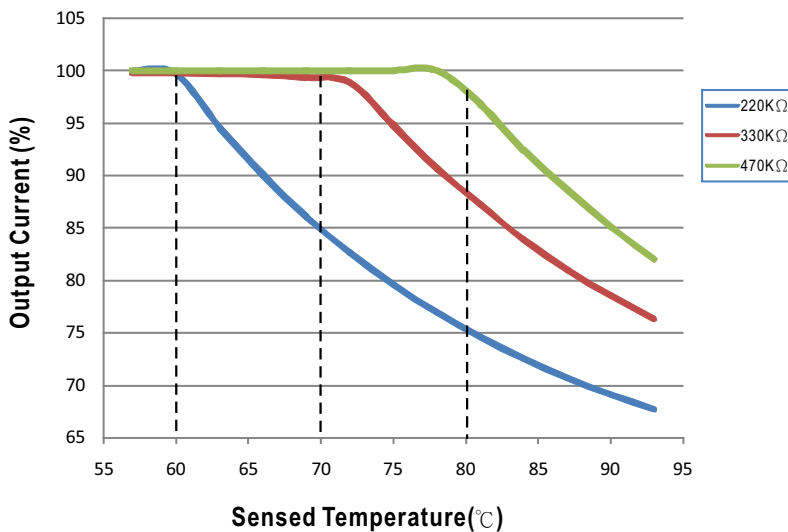

© LCM-60DA/DA2 can still be operated normally when the NTC resistor is not connected and the value of output current will be the current level selected through the DIP switch.

NTC reference:

NTC resistance	Output Current
220K	< 60°C, 100% of the rated current (corresponds to the setting current level) > 60°C, output current begins to reduce, please refer to the curve for details.
330K	< 70°C, 100% of the rated current (corresponds to the setting current level) > 70°C, output current begins to reduce, please refer to the curve for details.
470K	< 80°C, 100% of the rated current (corresponds to the setting current level) > 80°C, output current begins to reduce, please refer to the curve for details.

Notes: 1. MEAN WELL does not offer the NTC resistor and all the data above are measured by using THINKING TTC03 series.
 2. If other brands of NTC resistor is applied, please check the temperature curve first.

© Dimming and synchronization function of the driver will be invalid when the "temperature compensation" function is in use.

■ **OUTPUT LOAD vs TEMPERATURE**

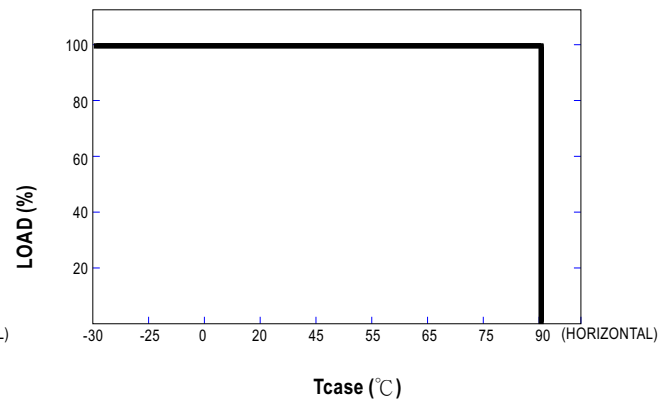
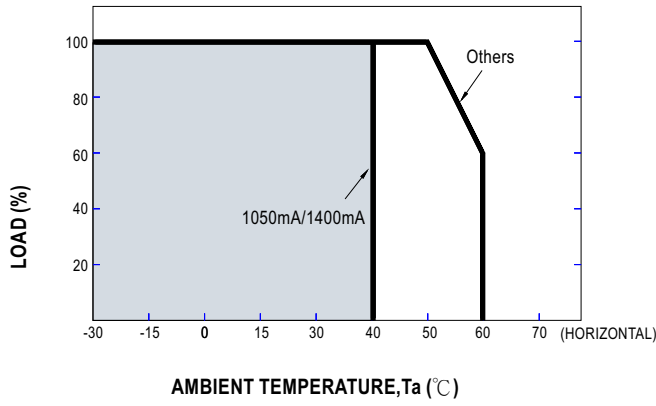

■ **STATIC CHARACTERISTIC**

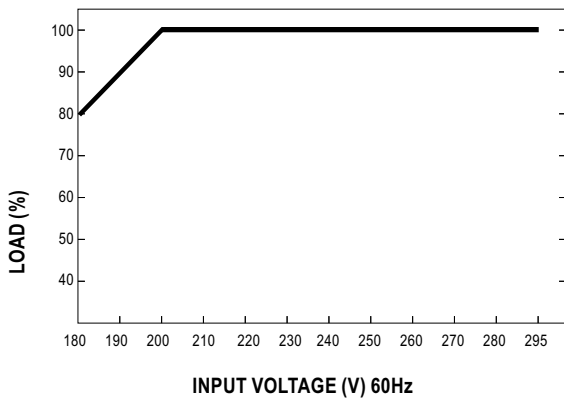

※ De-rating is needed under low input voltage.

TOTAL HARMONIC DISTORTION (THD)

※ Tcase at 80°C

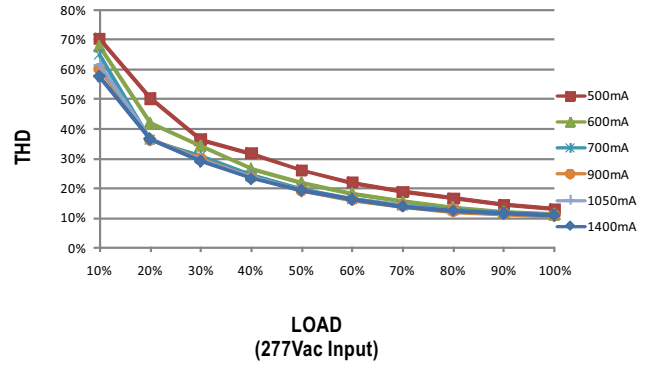
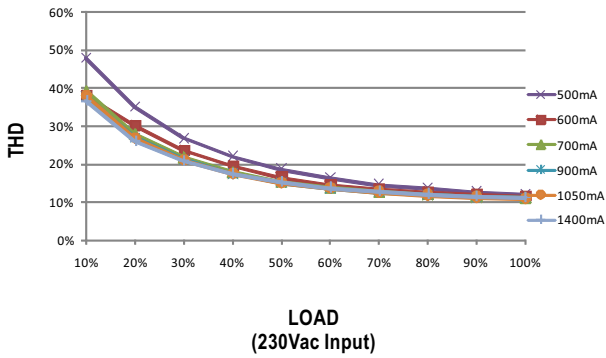

POWER FACTOR (PF) CHARACTERISTIC

※ Tcase at 80°C

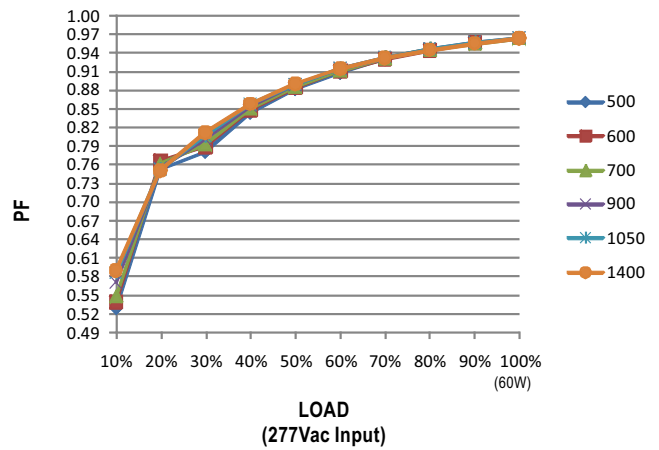
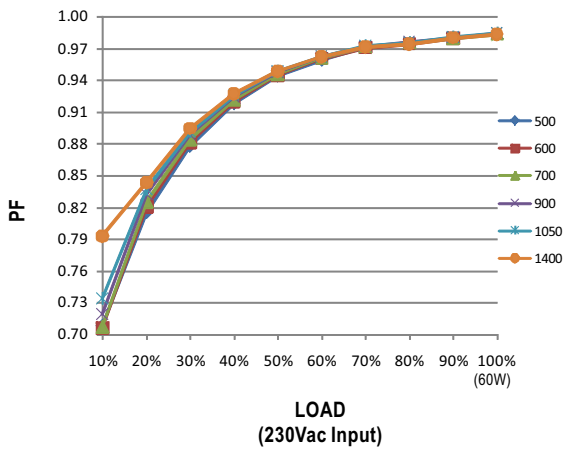

EFFICIENCY vs LOAD

LCM-60DA series possess superior working efficiency that up to 91% can be reached in field applications.

※ Tcase at 80°C

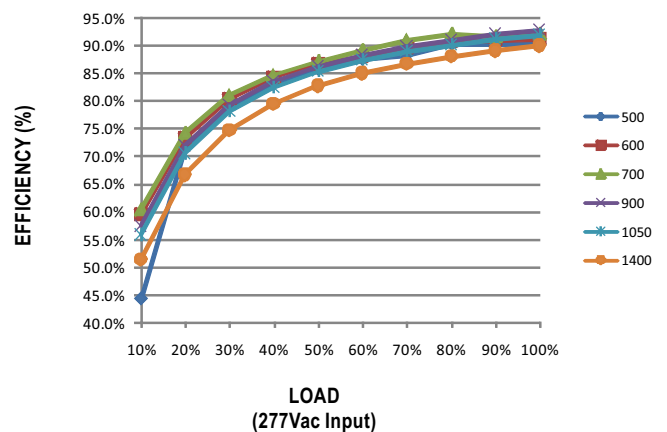
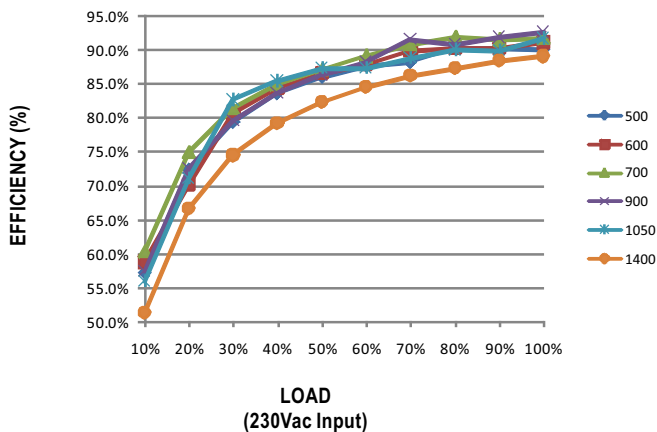

MECHANICAL SPECIFICATION

Case No.LCM-60A Unit:mm

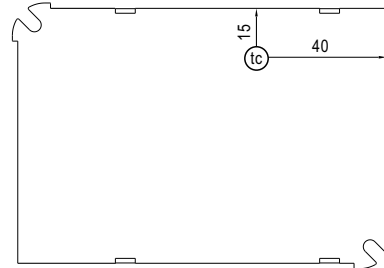
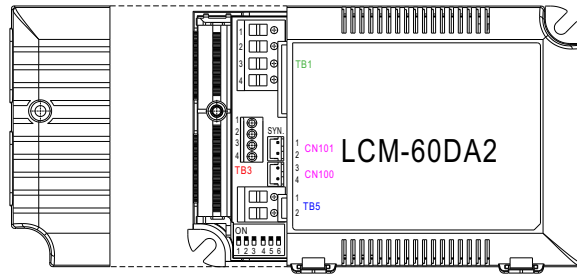
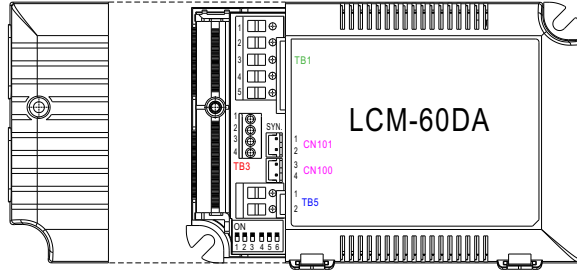
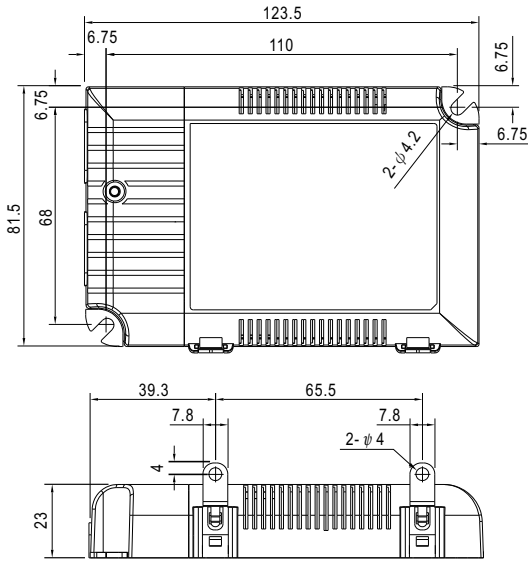

Bottom View

• (tc) : Max. Case Temperature

※ Terminal Pin No. Assignment(TB1)(LCM-60DA)

Pin No.	Assignment	Pin No.	Assignment
1	AC/L	4	DA+
2	AC/N	5	DA-
3	PUSH		

※ Terminal Pin No. Assignment(TB1)(LCM-60DA2)

Pin No.	Assignment	Pin No.	Assignment
1	AC/L	4	DA-
2	AC/N		
3	DA+		

※ Terminal Pin No. Assignment(TB3)

Pin No.	Assignment	Pin No.	Assignment
1	+FAN(+AUX)	3	+NTC
2	-FAN(-AUX)	4	-NTC

◎ Pin1(+FAN) / Pin2(-FAN) is the Auxiliary DC output for the optional model LCM-60DA-AUX; it can be used to drive fan.

※ Terminal Pin No. Assignment(TB5)

Pin No.	Assignment
1	+V
2	-V

※ SYN. Connector(CN101/CN100):JST B2B-XH or equivalent

Pin No.	Assignment	Mating Housing	Terminal
1,3	+	JST XHP or equivalent	JST SXH-001T-P0.6 or equivalent
2,4	-		

Installation Manual

Please refer to : <http://www.meanwell.com/manual.html>